

Laser Auto-Focus Module

The NANOBASE Laser Auto-Focus module dynamically maintains an excellent laser focus on the condition of the sample in real-time, ensuring consistent precision even on uneven surfaces or during movement.

This system delivers exceptional Raman measurement performance by precisely adjusting the laser focus reflected from the sample through advanced image analysis algorithms.

This ensures optimal measurement accuracy, especially for irregular samples, by maintaining a precise laser focus on the sample surface. It also reduces the need for manual adjustments, providing greater convenience for users.

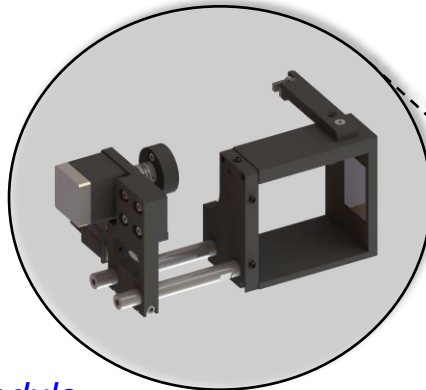
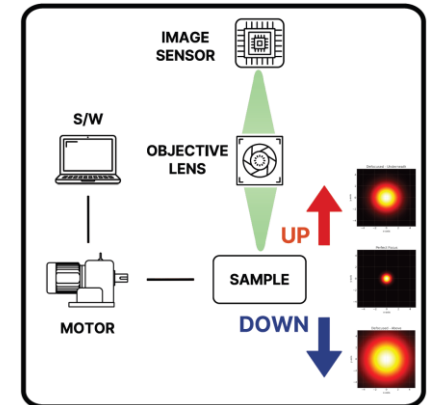

AF module

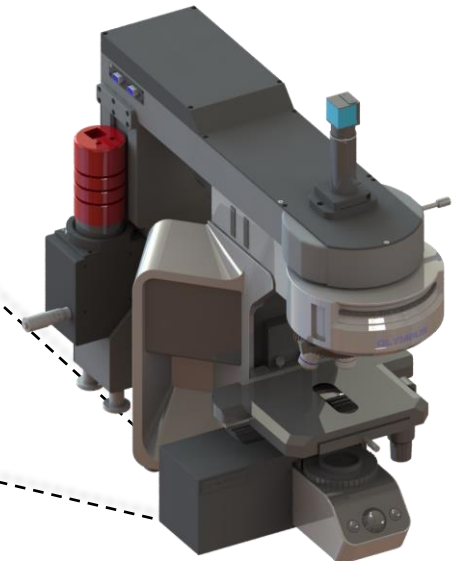

The module is fully compatible with Nanobase's XperRAM Raman spectrometer system and leverages advanced technology to deliver fast and precise focus adjustments, enabling high-resolution and high-sensitivity measurements.

What is Depth of Field

In our advanced laser autofocusing module for Raman spectroscopy, the Depth of Field (DOF) represents the range of distances from the sample where the laser remains sharply focused. This precision is crucial for accurate Raman signal acquisition. Raman measurements demand meticulous focus to enhance signal strength and minimize background noise.

A shallower DOF allows for high precision, enabling users to target specific layers within the sample effectively. Experience enhanced performance and superior data quality with our cutting-edge autofocusing technology.

$$DOF = \pm \frac{\lambda \cdot \sqrt{n^2 - NA^2}}{2 \cdot NA^2}$$

λ : Laser Wavelength

n : Refractive index between objective lens and sample

NA : Numerical Aperture of Objective lens

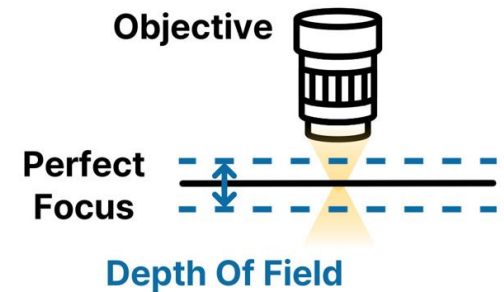

Factors such as laser wavelength, objective lens, and numerical aperture influence the DOF in Raman systems.

| | | | |
|----------------------------|--------------|--------------|--------------|
| Laser Wavelength (nm) | 405 | 532 | 633 |
| Refractive index (n) | 1 | 1 | 1 |
| Magnification | 40 | 40 | 40 |
| Numerical Aperture | 0.75 | 0.75 | 0.75 |
| Depth of Field (μm) | ±0.24 | ±0.31 | ±0.37 |

Laser Auto-Focus Module Performance (Mapping on Sloped Surface)

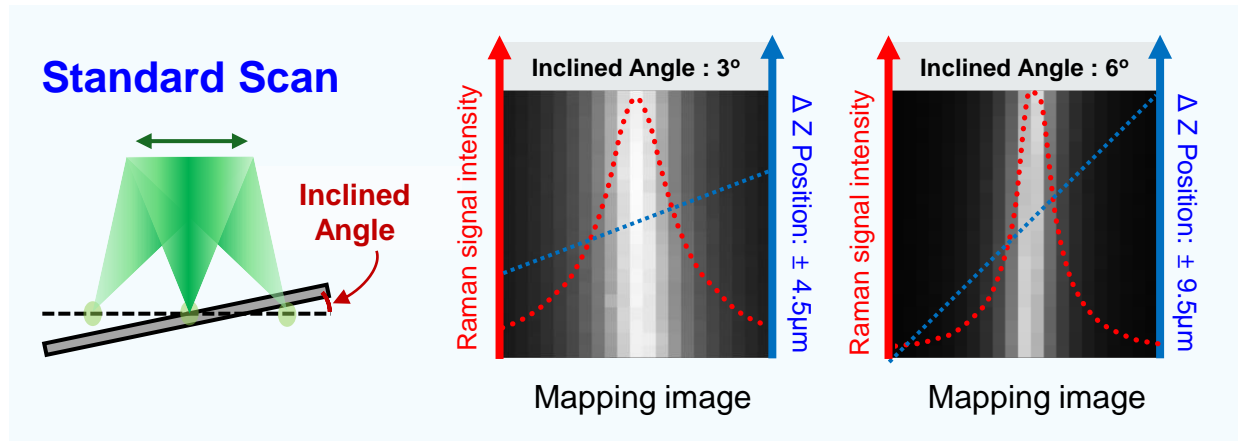

By utilizing Live Focus Scan, you can obtain uniform Raman signals from inclined sample surfaces without distortion in signal intensity. This real-time focus adjustment feature ensures optimal laser focus on the surface of the sample, allowing accurate Raman measurements for samples with various structures or shapes.

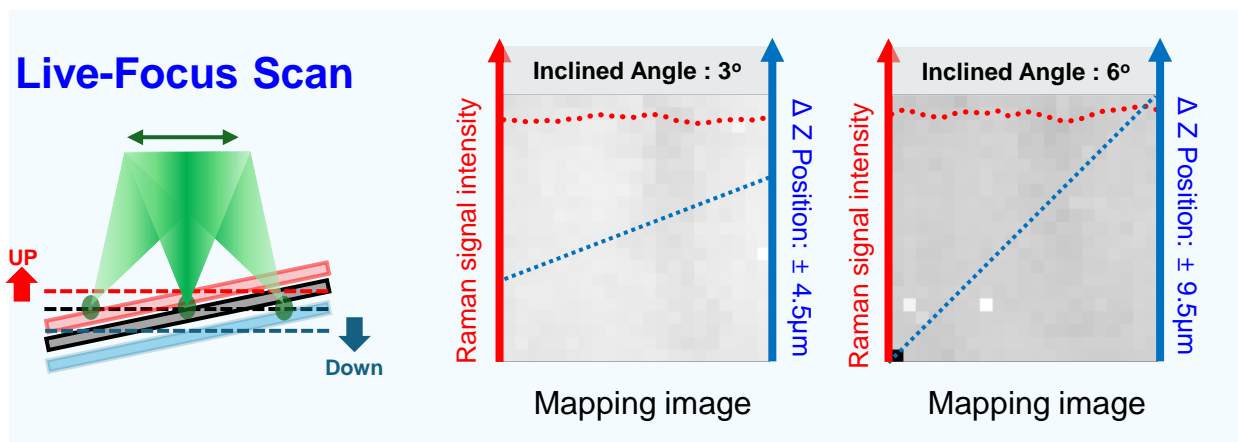

Laser Auto-Focus Module Performance

(Mapping on Random Size Particles)

Equipped with a precise auto-focus system, this module accurately tracks and maintains the laser focus position based on the depth of field, with a maximum operational height range of approximately 20 μm . These product characteristics ensure high-accuracy Raman measurement performance across various sample particle types and sizes

Standard Scan

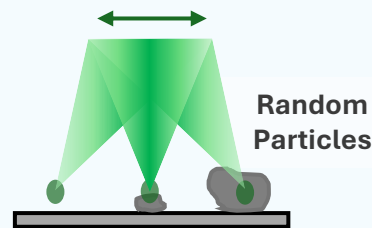

Optical image

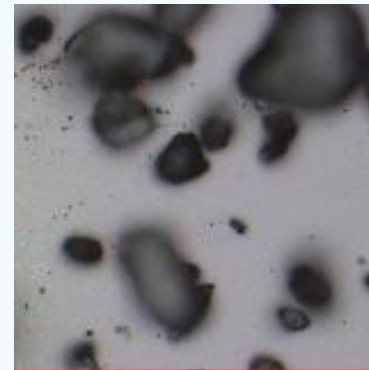

Mapping w/o Live-Focus

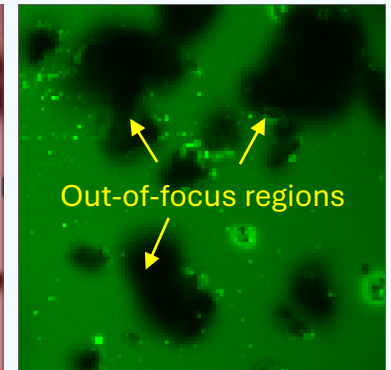

Live-Focus Scan

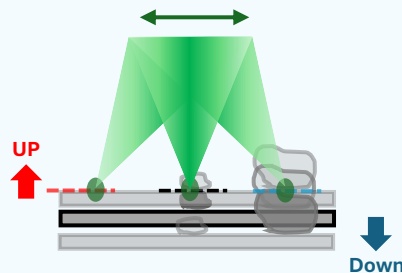

Mapping w/ Live-Focus

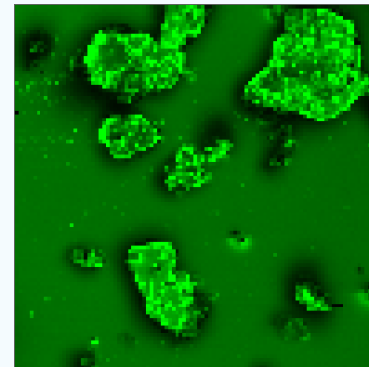

Height Map 2D image

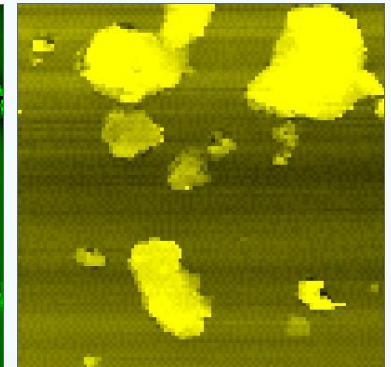

Laser Auto-Focus Module Performance

(Mapping on Patterned Surface)

The auto-focus system keeps the focus on patterned surfaces with varying heights and shapes. It adjusts automatically in real-time, ensuring more accurate and reliable measurements. This is especially useful for industries and academia using Raman spectroscopy, such as semiconductors and materials science, for high-resolution microscale analysis.

Standard Scan

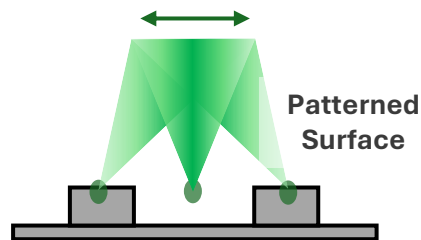

Optical image

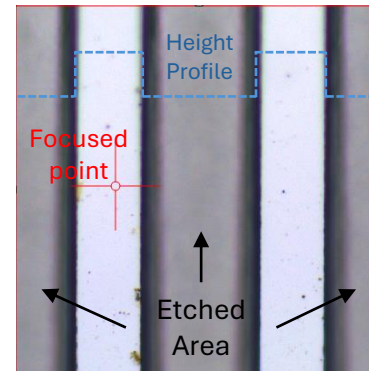

Mapping w/o Live-Focus

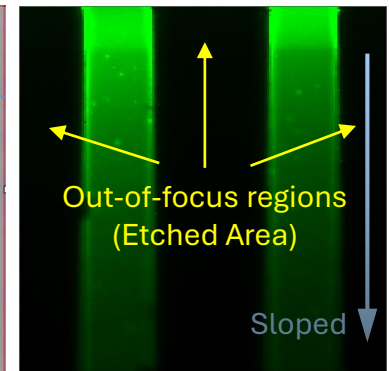

Live-Focus Scan

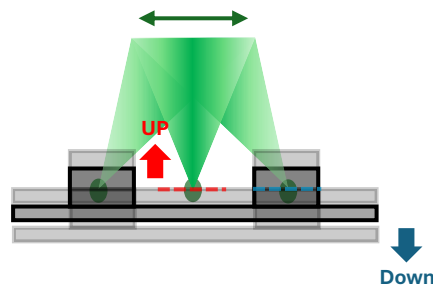

Mapping w/ Live-Focus

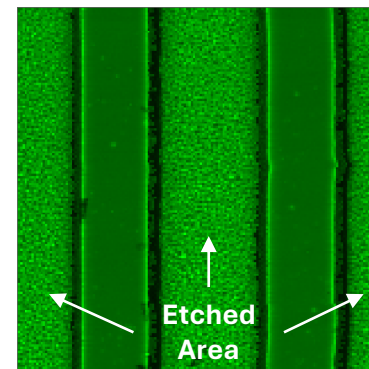

Height Map 3D image

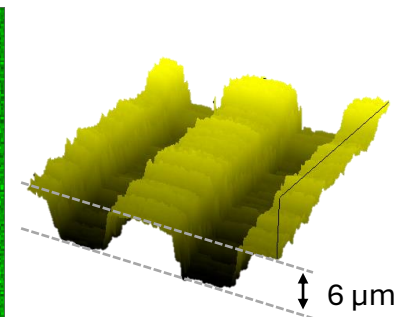

Why NANOBASE Laser Focus-Module

1.Live-Focus Scan: The module continuously adjusts laser focus in real time, compensating for surface irregularities or movement to maintain optimal focus during measurements.

2.Improved Accuracy: By ensuring precise focus, the module enhances the accuracy and reliability of Raman spectra, especially for uneven or sloped surfaces.

3.User Convenience: The automatic focusing feature reduces the time spent on manual adjustments, allowing users to save time and effort, especially during lengthy measurements or when measuring large areas.

4.Compatibility: Compatible with All XperRAM series, it can be easily upgraded into Nanobase's Raman spectrometer system.

5.Advanced Technology: Using image-tracking laser focus algorithms, the module enables rapid, precise focus adjustments, ensuring high-resolution and high-sensitivity measurements.

| Parameter | Description |
|----------------------------|---|
| Auto-Focusing algorithms | Image-based Focus-tracking technique |
| Focusing accuracy | Automatically adjusted depending on DOF |
| Maximum focusing height | ~ 20µm |
| Maximum scan range | 800 X 800 µm (@ 10X Obj.) |
| Supported objective lenses | 10X, 20X, 40X |
| Supported laser wavelength | 532, 633 nm |

- The performance may be limited by the laser power used in the measurement.*
- The performance may be limited in samples with low surface reflectivity or rough surfaces causing diffuse reflection.*